

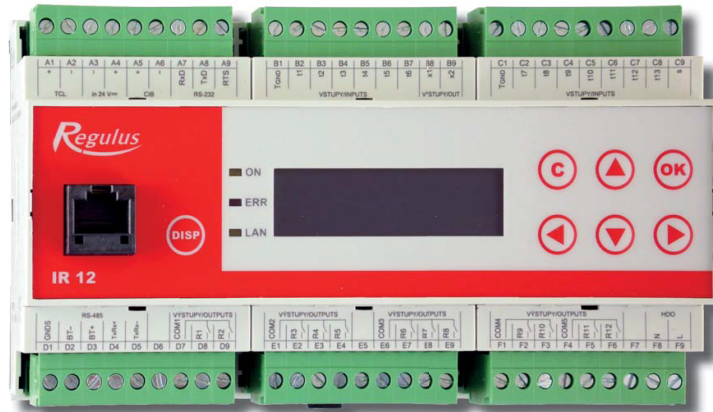

www.regulus.eu



IR 12_CTC

Users Guide
IR 12 Heating Controller
Ver.: IR12_CTC

EN

IR 12_CTC

Technical Description of IR 12 Heating Controller	3
1 How to operate IR 12 Controller	3
1.1 Basic User Menu	4
2. User menu	8
2.1 Zones – user settings	9
2.2 Ventilation unit – user settings	9
2.3 Time programs – user settings	10
2.4 OTC curve – user settings	11
2.5 Heat pump control	11
2.6 Heat pump errors	11
2.7 DHW storage tank heated by heat pump (DHW)	12
2.8 DHW storage tank heated by auxiliary source (DHW-E)	12
2.9 Setting temperatures for thermal store	12
2.10 DHW recirculation and time program settings	12
2.11 Statistics	13
2.12 Operating data	13
2.13 Others	13
2.14 Time and date setting – user settings	13
2.15 Regulis Route - remote access service	14
3 Additional modules	15
4 Web interface	16

Technical Description of IR 12 Heating Controller

Ver. IR12 CTC 400

IR 12 Heating Controller (ver. IR12 CTC 400) is a controller of heating systems with a CTC heat pump and solar thermal system. The controller can handle 2 heating zones with a mixing valve, DHW heating by a heat pump, DHW heating by an el. heating element and it can control a backup source (electric or gas-fired boiler).

IR 12 Heating Controller is controlled by 6 keys. Information is shown on a 4-line display. The Controller features 13 inputs for temperatures measured (by Pt 1000 temperature sensors) one universal input for a switch (r.g. a room thermostat) and one input for Ripple control signal. Further it features 10 relay outputs (250V 3A) and two triac outputs (250V 1A) capable of continuous control of circulation pumps.

The Controller is fitted with an Ethernet interface a service intervention, firmware upgrades and eventually elementary visualization of the concerned heating system. The Controller also features an RS 232 and RS485 communication interfaces. As an option, an OpenTherm module can be connected to the Controller for communication with a heat source.

This Controller controls CTC Heat Pumps.

1 How to operate IR 12 Controller

The controller is operated using 6 keys ◀, ▶, ▲, ▼, C, OK on its front panel.

The **DISP** key switches between User and Service display.

Note: The Service display is intended to show info on the Controller itself and therefore it is not needed during common operation.

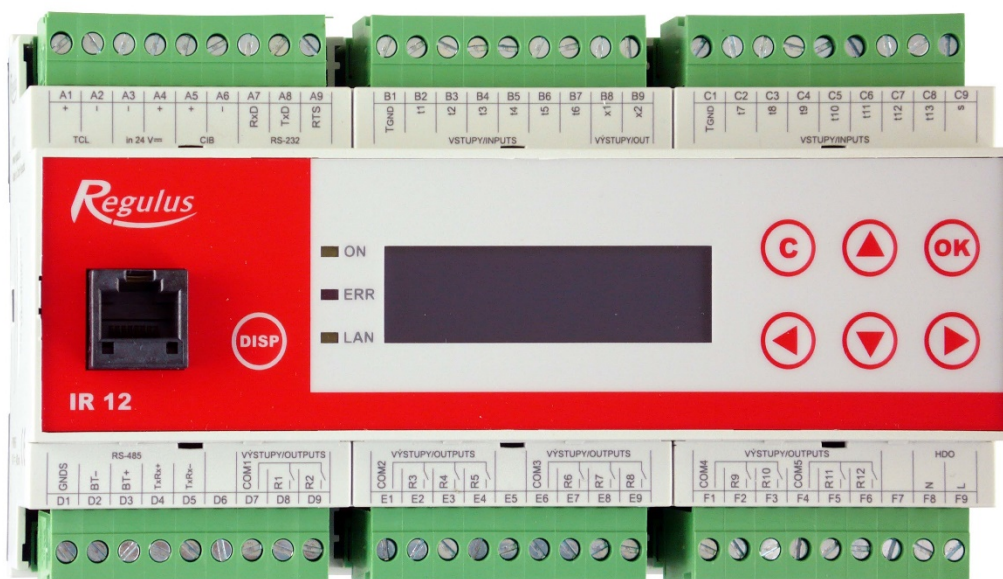

The keys **▲**, **▼** are used to browse in the menu. In order to edit a parameter, press **OK** and a cursor appears on the parameter. The values of numeric parameters can be increased/decreased by pressing **▲** / **▼** keys. Selection parameters (e.g. ON/OFF) are chosen by pressing keys **◀**, **▶**. When finished, pressing **OK** will move the cursor to the next parameter in the same display. Parameter editing can be also exited without saving by pressing the key **C**.

1.1 Basic User Menu

Pressing **C** in the basic User menu will always bring back the first – basic display.

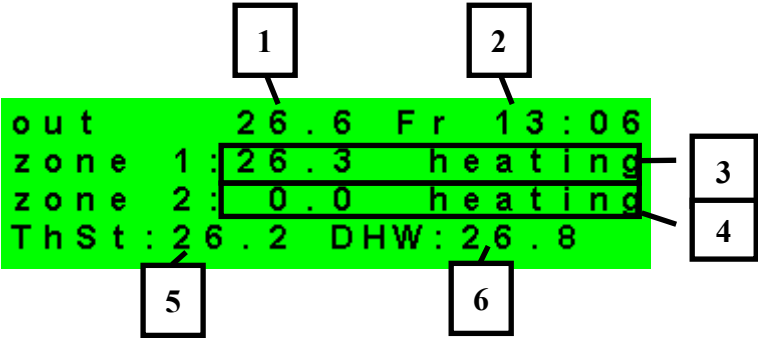

- 1 – outdoor temperature
- 2 – weekday and time
- 3 – temperature in zone (if room temp. sensor is used)
- 4 – heating water temperature (if no room temp. sensor is used)
- 5 – temperature in Thermal Store
- 6 – temperature in DHW storage tank

Heating zone display (zone 1, zone 2):

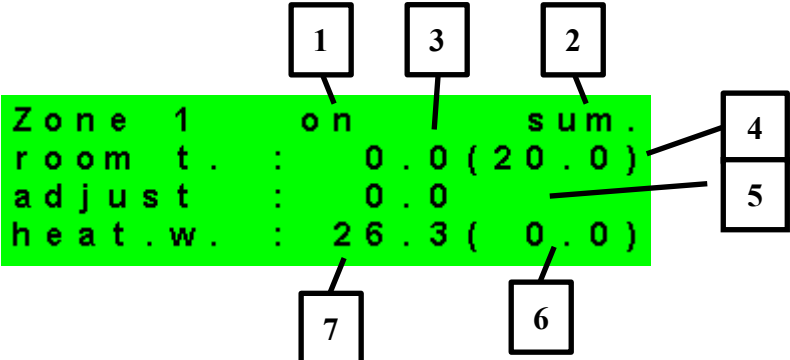

- 1 – zone NO / ON / OFF / blocked (by low ThSt temper.)
- 2 – controller mode winter / summer
- 3 – current room temperature. If no room sensor is used, the data is shown as 0.0)
- 4 – desired room temperature per program
- 5 – adjustment to the desired room temperature. When RC21 IR room unit is used, "PJ" appears and the adjustment made by this unit is shown
- 6 – desired heating water temperature for the zone
- 7 – current heating water temperature

The desired temperature can be adjusted via the parameter “*adjust*”.

Solar thermal system display:

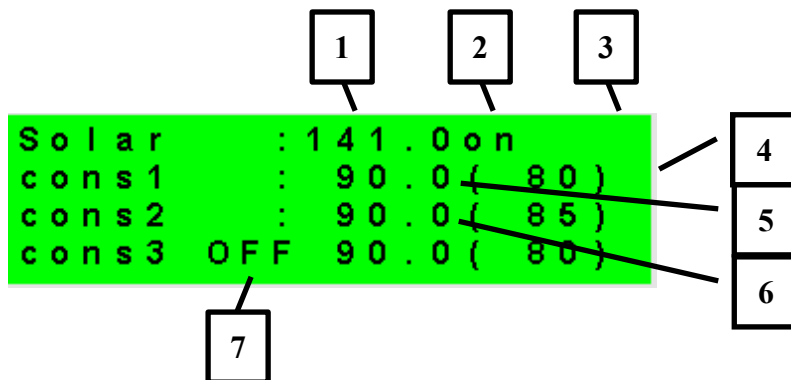

- 1 – solar collector temperature
- 2 – system ON
- 3 – ON= solar pump running
- 4 – currently charged consumer mark
- 5 – consumer 1, current temp (desired in solar heating)
- 6 – consumer 2, current temp (desired in solar heating)
- 7 – consumer 3, not used

DHW by auxiliary source display:

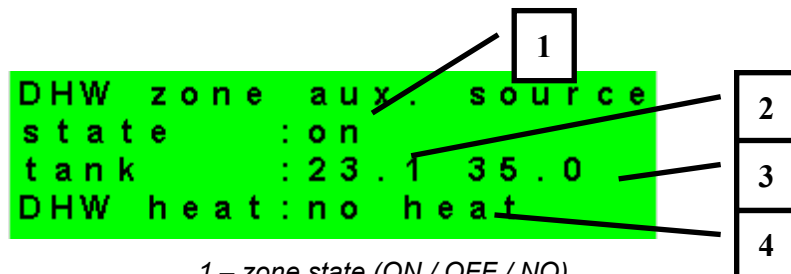

- 1 – zone state (ON / OFF / NO)
- 2 – current temperature in DHW tank
- 3 – desired temperature in DHW tank
- 4 – heating by el. element (heat / no heat)

DHW by Heat Pump display:

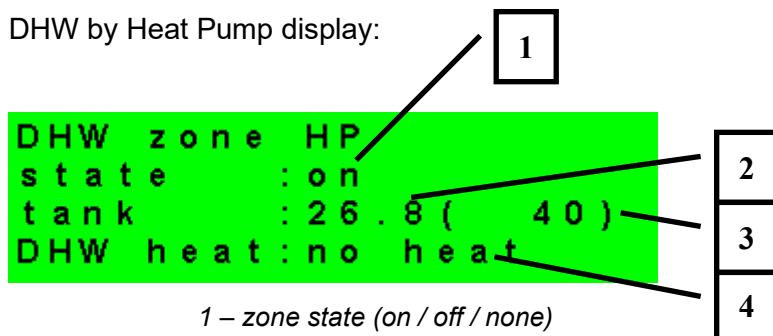

- 1 – zone state (on / off / none)
- 2 – current temperature in DHW tank
- 3 – desired temperature in DHW tank
- 4 – heating by heat pump (heat / no heat)

Heat Pump, cascade display:

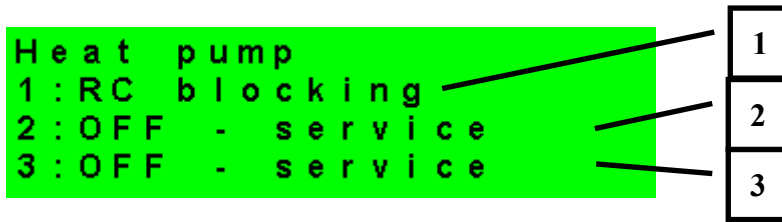

1 – state of heat pump No. 1

2 – state of heat pump No..2

3 – state of heat pump No. 3

In this section, heat pump states are shown that are enabled on the Service level. The states can be following:

- OFF - service : heat pump is turned off by a heating engineer
- OFF – user : heat pump is turned off on the User level
- fault : heat pump is in alarm mode, alarm details are shown on the User level in HP Alarms menu
- return - max.T : heat pump is blocked by max. possible return temperature
- flow - max.T : heat pump is blocked by max. possible flow temperature
- ambient – min.T : heat pump is blocked by min. possible outdoor temperature
- ambient – max.T : heat pump is blocked by max. possible outdoor temperature
- sup.refrig.vapor : heat pump is blocked by max. compressor temperature
- high T earth circ. : heat pump is blocked by max. brine circuit temperature
- vapor –low T : heat pump is blocked by low evaporation temperature
- vapor – high T : heat pump is blocked by high evaporation temperature
- cond. – high T : heat pump is blocked by high condensing temperature
- EEV-low T intake : heat pump is blocked by expansion valve’s low suction gas temp.
- EEV-low T vapor : heat pump is blocked by expansion valve’s low evaporation temper.
- EEV-high T vapor : heat pump is blocked by expansion valve’s high evaporation temper.
- EEV-low superheat : heat pump is blocked by expansion valve’s low superheat temper.
- EEV-high p cond. : heat pump is blocked by expansion valve’s high condensing temper.
- high pressure : heat pump is blocked by high refrigerant pressure
- defrosting : heat pump is defrosting (only for air/source heat pumps)
- min.run time : HP min. running time is active. This activates always after start, DHW heating or defrosting
- DHW heating : heat pump is heating DHW
- rebooting : heat pump is blocked by min. time between 2 comperssor stars
- heating : heat pump is heating your home
- RC blocking : heat pump is blocked by Ripple control
- vol.flow control : heat pump’s circulation pump is running
- ready : heat pump is ready to start heating as soon as there is call for heat

Display of auxiliary source and thermal store:

```
ON/OFF sour.DHWprot.
Th.Store: 22.7 ( 0.0)
Ripp.c. : off
```



- 1 – state of auxiliary source: heat / no heat / none
- 2 – current thermal store temperature (desired)
- 3 – Ripple c. signal: on / off

Display of auxiliary source connected via OpenTherm interface:

```
OpenTherm sour. none
req.temper. : 0.0
flow temp. : 0.0
communicat. : OK
```

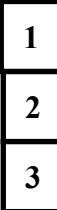

- 1 – desired temperature
- 2 – real flow temp. of OT source
- 3 – state of communication with OT source: OK / error

Display with firmware version and release date:

```
IR12 CTC 400 - 202
FW: 02.09b
12.07.2016
www.regulus.cz
```

Controller in factory settings:

```
!WARNING!
After failure
controller reset to
FACTORY SETTINGS!!!
```

If the display shows the warning (above), then the Controller has been reset to factory setting after alarm mode, and service staff shall be called in to set the respective Controller parameters.

Menu:

```
*****
*          settings          *
*    <for user>             *
*****
```

While in MENU, use arrow keys <, > to select user or service menu, or displaying additional modules.

Add. Modules – this item will make available basic information on additional modules (if present).

User Menu is intended to set zones, time schedules, OTC curve and date/time.

Service Menu is intended for more detailed adjustments to zones, sources, solar thermal system and other parameters..

Access to the Service Menu is password protected and parameter adjustments are not intended for laymen!

Recirculation is intended to set immediate DHW recirculation (circulation period). After the set recirculation time expires, the function will be turned off automatically.

Z3 to Z6 is intended to set immediate parameters of zones 3 to 6 (zones 3 to 6 have to be connected via additional modules). The adjustment is simplified from zones 1 and 2 (see 2.1.).

2. User menu

User menu is comprised of:

- Zone 1
- Zone 2
- Ventilation unit (HVAC unit)
- Time program (time programs, holiday program)
- OTC curves
- HP (heat pump)
- DHW (DHW heating by heat pump)
- DHW-E (DHW heating by auxiliary source)
- ThSt (thermal store charging)
- DHW recirculation
- HP errors (error log)
- Statistics (heat pump statistics)
- Operating data (inputs and outputs)
- Others (Controller website username and password reset)
- Time and date (time and date)

The keys <, > enable browsing, and the selected item can be entered by pressing **OK**.

User menu:



2.1 Zones – user settings

In this Menu, a user can adjust these parameters:

T comfort - setting comfort temperature in zone. This parameter makes sense only when a room sensor is used.

T setback - setting setback temperature in zone. This parameter makes sense only when a room sensor is used.

Note: During a day, the controller switches the desired zone temperatures between T day and T night by the preset time schedule..

zone on - Switching on Zone on the User level. When zone is switched off on this level, the circulation pump and valve outlets will be switched off. The pump and valve outlets can be activated by frost protection, if active.

Summer/winter mode state

- Switching on/off the function for automatic transition between summer and winter modes. Summer/Winter mode is intended to turn off zone heating when the outdoor temperature exceeds the preset threshold **summer** temperature, and vice versa, to turn on zone heating when the outdoor temperature stays below the preset threshold **winter** temperature.

summer temp (°C) - If the outdoor temperature keeps above this value for the time set in parameter **summer time**, the Controller will switch to **summer** mode.

summer time (h) - see **summer temp**.

winter temp (°C) - If the outdoor temperature keeps below this value for the time set in parameter **winter time**, the Controller will switch to **winter** mode.

winter time (h) - see **winter temp**.

2.2 Ventilation unit – user settings

In this Menu, a user can adjust these parameters:

comfort - HVAC power settings during a „comfort“ mode from 0 to 100%.

setback - HVAC power settings during a „setback“ mode from 0 to 100%.

Note: During a day, the controller switches the desired HVAC power between comfort and setback by the preset time schedule.

zone on - Switching on Zone on the User level. When the zone is off then the ventilation unit is switched off.

Boost function 1, 2, 3 - Switching on the Boost function. HVAC power will be temporary raised to the set **power** level for a time span set by the **period** value. After the expiration of this period the function will switch off and the HVAC unit will be switched back to automatic mode. This function could be switched on by a button connected to one of the controller's inputs (see service manual for settings).

Summer bypass - Switching on the Summer bypass function. This function is controlled either by zone 1 or zone 2 room sensor (select the sensor in parameter **assign function to**). The room sensor is compulsory for switching the zone on – if neither of the zones have room sensor or room controller present then the function could not be switched on. This function opens the bypass flap when the outside temperature is lower than set temperature (**request t.**) on the selected room sensor. The outside temperature has to be higher than set minimum value (service level parameter). It is possible to control this zone only in summer mode of selected zone (operation in either both modes or only in summer mode could be set in service level).

The setting of the time program for separate days of HVAC unit follows immediately after these settings. When the program is being set for separate days, there are 2 transitions from Comfort to Setback and 2 from Setback to Comfort for each day.

2.3 Time programs – user settings

Time programs can be set either for separate days, or in blocks Mo-Fr and Sa-Su. When the program is being set for separate days, there are 2 transitions from Comfort to Setback and 2 from Setback to Comfort for each day.

```
Mo    c o m f o r t 1 : 0 6 : 0 0
-     s e t b a c k 1 : 0 8 : 0 0
Fr    c o m f o r t 2 : 1 6 : 0 0
Z 1   s e t b a c k 2 : 2 2 : 0 0
```

When the program is being set in blocks, there are similarly 2 transitions from *Comfort* to *Setback* and 2 from *Setback* to *Comfort* for the blocks Mo-Fr and Sa-Su. Answering YES to the question Copy program? will rewrite the respective time program blocks.

```
copy program?
no
```

If program copying is not desired, let the question be with no and leave the menu by pressing **C**.

Holiday mode – specific temperatures in zones can be set for the holiday period.

2.4 OTC curve – user settings

The weather-compensating heating curve in IR Controllers is calculated from heating system parameters and can be shifted in parallel or its inclination changed at two points, namely -15°C and +15°C outdoor temperature. When editing the correction value of one point, the other one always remains unchanged and the curve changes its inclination. For a parallel shift, the same correction at both the points shall be made.

OTC curve shift - OTC curve shift at -15 °C and +15 °C.

The next two displays contains OTC curve representation for both zones (1 and 2). For each of the 4 outdoor temperatures (described as E1, E2, E3, a E4) a desired heating water temperature of I1, I2, I3 a I4 is displayed.

2.5 Heat pump control

A heat pump can be switched off by the user.

```
HP
HP1:  on
HP2:  off
HP3:  off
```



1 – single HP on / off

2.6 Heat pump errors

In this menu item all heat pump errors can be reset and HP error log is available. The following display is shown:

```
Reset all
errors   : No
Press down arrow
to show history
```

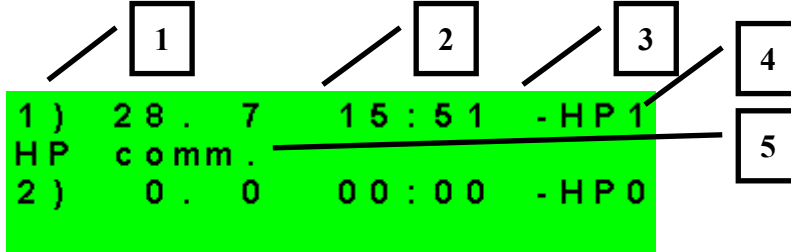

1)	28 . 7	15 : 51	-HP 1
HP comm.			
2)	0 . 0	00 : 00	-HP 0

1 – error serial number (1 – 10)

2 – date & time of error occurrence

3 – information if the error is still active

4 – number of HP with error (1 – 10)

5 – error type

2.7 DHW storage tank heated by heat pump (DHW)

If this heating is enabled in the Service menu, a hot water storage tank is heated by a heat pump. Heating is performed by the preset time schedule and the set Comfort and Setback temperatures..

- DHW on** - Manual switching on DHW heating by a heat pump.
- T comfort** - Comfort temperature. Hot water storage tank is heated to this temperature if it is set to "Day" program for the time in question.
- T setback** - Setback temperature. Hot water storage tank is heated to this temperature if it is set to "Night" program for the time in question.

2.8 DHW storage tank heated by auxiliary source (DHW-E)

- DHW-E on** - Manual switching on DHW heating by an el. heating element.
- T comfort** - Comfort temperature. Hot water storage tank gets heated up to this temperature if the program is set to "Comfort" at the moment.
- T setback** - Setback temperature. Hot water storage tank gets heated up to this temperature if the program is set to "Setback" at the moment.

Anti Legionella:

Anti-Legionella function helps "disinfect" hot water storage tanks, namely it kills Legionella bacteria.

When this function is ON, the hot water storage tank heats up to 65°C once in a week, at a preset time on a preset day. Heating is switched off either when this temperature is reached, or after two hours of heating disregarded of the temperature.

- on (on/off)** - Turns Anti Legionella function on.
- day (weekday: mo-su)** - Day when heating up starts.
- Hour (hour)** - Hour when heating up starts.

2.9 Setting temperatures for thermal store

- ThSt on** - Switchin on Thermal Store zonn .
- T comfort** - Comfort temperature. Thermal store gets heated up to this temperature if the program is set to "Comfort" at the moment..
- T setback** - Setback temperature. Thermal store gets heated up to this temperature if the program is set to "Setback" at the moment.

2.10 DHW recirculation and time program settings

Here DHW recirculation is enabled and the time schedule of the pump set. When recirculation is on, it is performed following the time schedule set for each day. The time schedule defines from-to operation times. For this period, circulation time and idle time can be set if continuous operation is not desired. E.g. Monday from 6.00 a.m. to 10.30 p.m. the recirculation pump will always run for 10 min. and then idle for 15 min.

on (off / on) - - Recirculation switched on..

circ. time (min) - - Circulation time setting.

idle time (min) - - Idle time setting.

circulation times - - Time setting for separate days when recirculation is on.

2.11 Statistics

HP statistics is displayed here, i.e. number of compressor starts and operating time.

2.12 Operating data

All input temperatures and logic values of controller output are displayed here.

```
o u t           0 . 0
z o n e  1     0 . 0   o f f
z o n e  2     0 . 0   o f f
h e a t  z 1   0 . 0 ( 0 . 0 )
```

An **E** letter at the end of the temperature sensor line means that the temperature sensor is out of its permitted working range. Its proper connection or the sensor itself shall be checked.

2.13 Others

website password reset (no,reset) - Controller website username and password reset for User level. By resetting the default values are set (username: user, password: user)..

language for error messages and HP state: - Language for error messages and HP state shown on the display and website.

2.14 Time and date setting – user settings

Time and date shall be set to ensure proper operation of time programs. Clock is set in 24 hour format, weekdays are selected using ◀, ▶ keys, Mo-Fr.

Time and date setting

```
          s e t   t i m e
h o u r s       :   1 3
m i n u t e s   :   0 6
```

After time and day are set, pressing ▼ key will show the display :

```
Saving time      OK
press "C" for return
```

When this display is shown, time and date are saved into the controller's real time circuit.

2.15 Regulus Route - remote access service

RegulusRoute service enables remote access to the Controller avoiding the need to use a public IP address. If you wish to have this service configured, kindly contact Regulus.

RegulusRoute (yes/no) - Enabling RegulusRoute service

Status - RegulusRoute service state

Then follows the information about IR driver and remote server of this service along with a detailed description of the last fault state. All three parameters could be useful when solving connection errors with our service technicians.

IR12 name - Controller login name to RegulusRoute service

3 Additional modules

In the menu *Additional modules* on User level, user information on additional modules (if present) can be viewed.

Fire Module:

```
Fire          absent
temperature:  0.0 °C
damper        : 00%
DHW pump      : none
```

Temperature (displayed °C) - Fireplace flow temperature.

Damper (displayed %) - Fireplace combustion-air damper opened.

DHW pump (on/off) - Display of pump on/off for DHW heated from Thermal Store or fireplace.

UNI Module:

```
UNI module    absent
output        : off
temp. 1       : 0.0
temp. 2       : 0.0
```

Output (on/off) - State of UNI universal module output displayed

T1 (displayed °C) - T1 temperature from UNI module

T2 (displayed °C) - T2 temperature from UNI module

4 Web interface

The controller involves an integrated website showing a heating system overview and user settings.

For its website access, the controller shall be connected to a LAN or directly to a PC using a network cable. IP address of the controller can be retrieved by pressing the *DISP* key and then the down arrow. This will display info on its network settings. Pressing *DISP* again will return the controller to user display.

After the controller is connected to a LAN, entering its IP address into the browser address bar, the login form will appear:

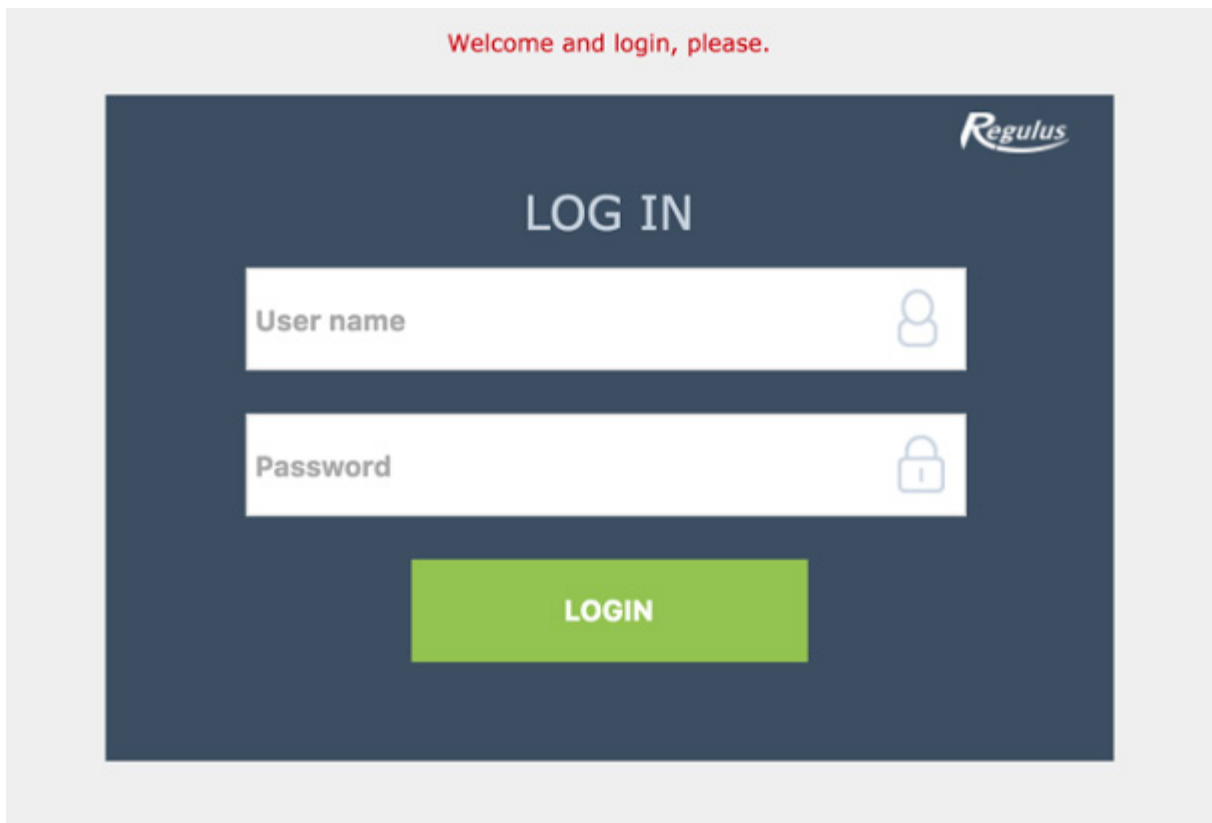

>Welcome and login, please.

Regulus

LOG IN

User name 

Password 

LOGIN

Login name for user level is: **user**,
Password for user level is: **user**.

After successful login the welcome screen appears for User level, making available pages with settings.

IR 12 Controller

Service guide

IR12_CTC

FW: 4.11

S 1 – Controller wiring:	18
Description of terminals	18
S2 -Technical data for IR12 Controller:.....	18
S3 – Technical data for OpenTherm™ boiler control module IR1x OT	19
S4 – Controller installation:.....	19
S4.1 – Wiring diagram	19
S4.2 – Wiring diagram with OT module.....	20
S 5 – Service menu:	21
S 5.1 – setting service parameters for Zones 1 and 2:	22
S 5.2 – setting service parameters for ventilation unit:	22
S 5.3 – floor drying program:.....	23
S 5.4 – setting service parameters for solar thermal system:	23
S 5.5 – setting service parameters for heat pumps – HP:	25
S 5.6 – HP operating data.....	27
S 5.7 – HP blocking	28
S 5.8 – setting service parameters for a switched auxiliary source:.....	28
S 5.9 – setting service parameters for an auxiliary source with OT:	28
S 5.10 – setting service parameters of a modulated (0-10V) heat source	29
S 5.11 – setting service parameters for DHW heating by a heat pump (DHW):.....	29
S 5.12 – setting service parameters for DHW heating by an additional source (DHW-E): ..	30
S 5.13 – setting service parameters for thermal store heating:.....	30
S 5.14 – sensor management:	30
S 5.15 – other service parameters:	30
S 5.16 – Fire module:.....	31
S 5.17 – UNI module:.....	32
S 5.18 – HW addresses of add-on modules:.....	33
S 5.19 – IP addresses:.....	33
S 5.20 – RegulusRoute:.....	34
S 5.21 – output test:.....	34
S6 – Web Server – service level:.....	35
S 6.1 Access to Service web interface, checking the IP address of the Controller:	35
S7 - RC21 IR Room Unit, wiring	36
S8 - Room thermostat, wiring	36

S 1 – Controller wiring:

Warning: Controller wiring may be performed by a qualified person only. Layman adjustments of the controller may cause damage to parts of the system.

Description of terminals

Lyra/Vega	TČ	IR 12		TČ		Lyra/Vega
HP comm. 3						OT modul comm. +
						OT modul comm. -
HP comm. 2						power -24V
HP comm. 1						power +24V
power L						CIB modules (e.g. UNI module)
solar pump						CIB modules (e.g. UNI module)
HP circulation pump						
power L						sensor common ground
zone 1 valve opens						solar
zone 1 valve closes						sensor 5
zone 1 pump						sensor 4
						sensor 3
power L						sensor 2
zone 2 valve opens						sensor 1
zone 2 valve closes						uni1 (dif./0-10V/cirk./ PWM hp/PWM sol)
zone 2 pump						uni2 (dif./0-10V/cirk./ PWM hp/PWM sol)
power L						sensor common ground
electric heat 2	DHW - add. source					DHW
electric heat 1	source ON/OFF					thermal store
power L						heating water - zone 2
DHW diverter valve						heating water - zone 1
uni3 (sol.consum.2 / differ. t. / recirc. DHW)						zone 2
						zone 1
Ripple Control N						outside
Ripple Control L						universal input (i.e. valve 1 signal)

S2 -Technical data for IR12 Controller:

Power supply

Voltage	24V DC ± 5%
Power consumption	max. 9.6 W
Installation	power distribution box, DIN rail (9 modules)
IP rating	IP 10B
Working temperatures	0 – 50 °C
Relative humidity	10% - 95% non-condensing

R1, R2 Outputs

Max. current over common	
COM terminal	2 A
Relay current	1 A (230V AC)
Relay type	semi-conductor

R3-R12 Outputs

Current over common	
COM terminal	10A
Relay current	3A (12 – 230V AC)
Relay type	electromechanical

0-10V Output

Output voltage	0-10V DC
Common conductor	T _{GND}
Max. current	10mA

Inputs:

Temperature inputs	resistance sensors Pt 1000 (-90°C to 250 °C)
Common terminal	T _{GND}

S3 – Technical data for OpenTherm™ boiler control module IR1x OT

Power supply:

Voltage	24 V DC ± 5%
Power consumption	max. 0.24 W
Installation	power distribution box, DIN rail (1 module)
IP rating	IP 10B
Working temperatures	0-50 °C
Relative humidity	10-95%, non-condensing

S4 – Controller installation:

The Controller is designed to be installed on DIN rail in a power distribution box. It may be installed by a properly qualified person only!!

The Controller and power supply unit shall be installed next to each other (see wiring fig.). The recommended min. cross section of the power supply conductors is 0.75mm².

S4.1 – Wiring diagram

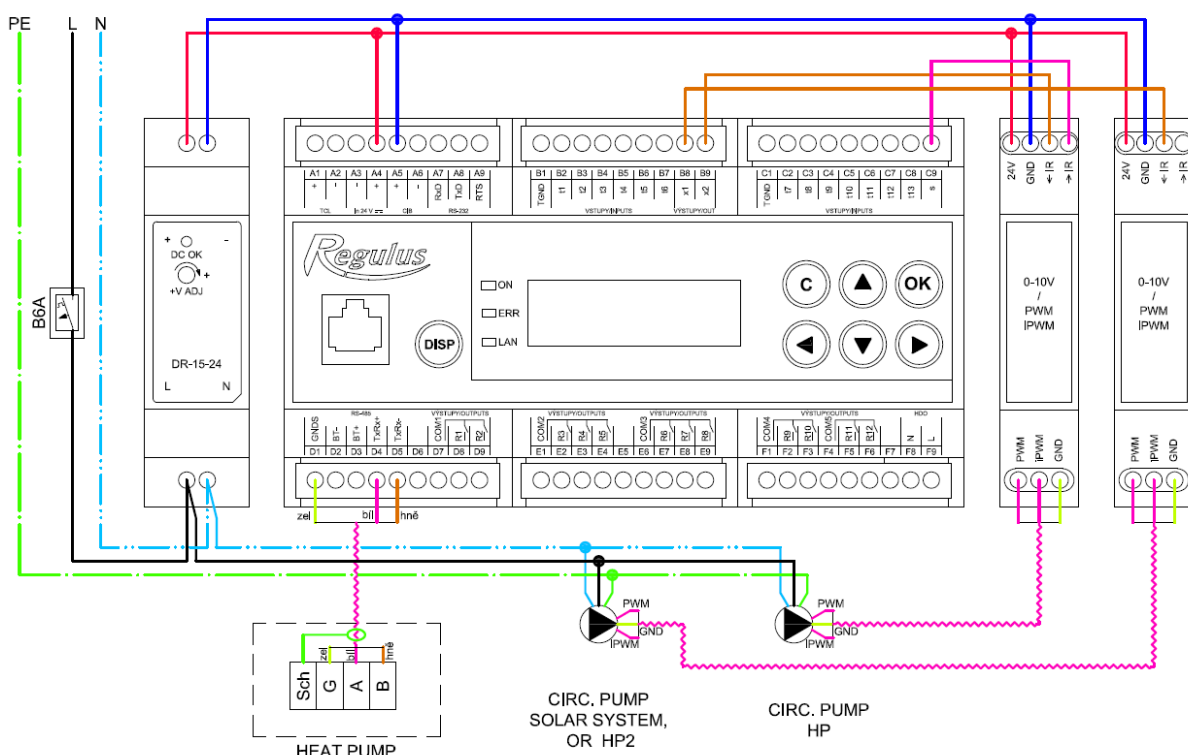

Fig. wiring connection of the power supply, the iPWM module for controlling the heat pump circulation pump, the solar circulation pump and the heat pump to the controller.

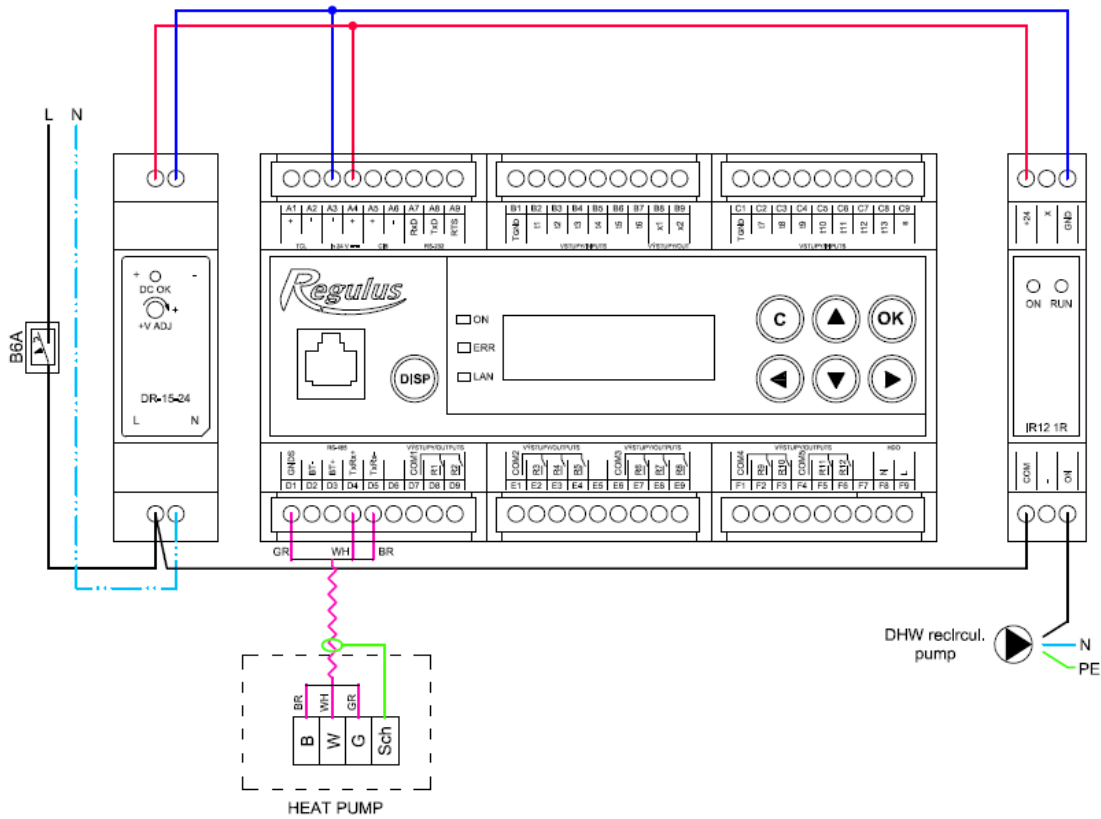

Fig. wiring of power supply unit, circulation module and heat pump to the controller.

S4.2 – Wiring diagram with OT module

The address switch of the OT module shall be set to pos. 0.

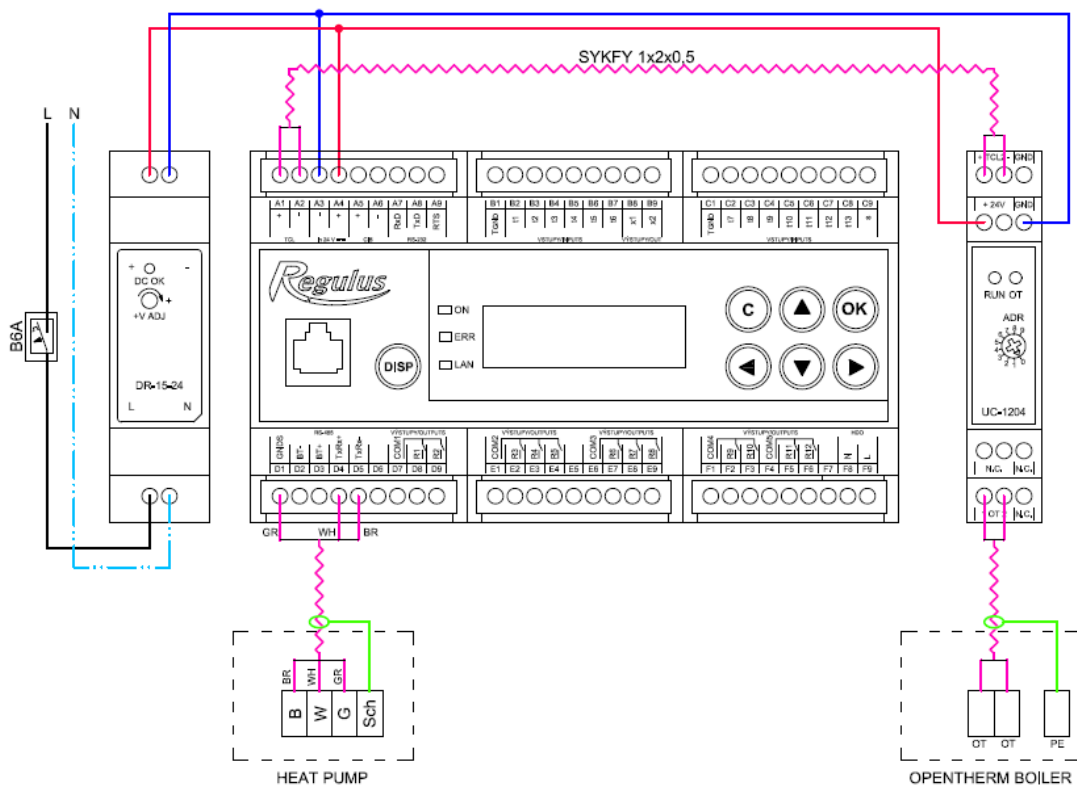

Fig. wiring of power supply unit, OT communication module and heat pump to the controller..

S 5 – Service menu:

Warning: Service menu may be edited by a specialist only. Layman adjustments of parameters in the Service menu may lead to damage to parts of the heating and/or solar thermal system.

In the User menu, the Service option shall be selected in order to enter Service menu, and confirmed by **OK**.

Entering a password to enter Service menu



By repeated pressing **OK** you browse password numbers. The numbers not being edited are shown as *. After all numbers have been entered, press ▼ (down arrow). The default service password is: 1234.

It is highly recommended to change the default password to your own!

The Service menu consist of these items:

zone 1	- setting service parameters for Zone 1
zone 2	- setting service parameters for Zone 2
ventilation unit	- setting service parameters for HVAC unit
floor drying	- setting service parameters for floor drying program
solar	- setting service parameters for solar thermal system
HP	- setting service parameters for heat pump
HP oper. data	- detailed info on heat pump
HP blocking	- detailed info on heat pump
source on/off	- setting service parameters for ON/OFF source
source OT	- setting service parameters for source with OT communication
DHW	- setting service parameters for DHW by a heat pump
DHW-E	- setting service parameters for DHW by an auxiliary source
ThSt	- setting service parameters for thermal store heating
control code	- control type setting depending on the tank type used
sensors	- temperature sensors management (offset, sensor condition)
other	- setting other service parameters
Fire module	- setting parameters for Fire add-on module
Uni module	- setting parameters for UNI add-on module (universal)
Addit. module address	- setting HW addresses for Fire and UNI add-on modules
IP address	- setting IP address, subnet mask, default gateway, DNS server
RegulusRoute	- setting RegulusRoute service
output test	- controller output tests

S 5.1 – setting service parameters for Zones 1 and 2:

zone (on/off) - Service switch on / off the zone. When a zone is switched off on service level, there is no zone frost protection function.

max.t do zone (°C) - Setting max. heating water temperature into a zone. The desired temperature calculated by Controller will not exceed this set value.

min.t do zone (°C) - Setting min. heating water temperature into a zone. The desired temperature calculated by Controller will not be below this set value.

room sensor (none, Pt, RC21, RCM2,therm) - Selection if a temperature sensor (Pt1000), a room unit (RC21) or room unit with display (RCM2) is used, or if the controller works without a room sensor. Or you can choose thermostat (therm) for switching between comfort and setback temperature. For zone 2 there is an extra option (fromZ1) and in such a case the data from RC21 unit wired to zone 1 are valid for zone 2.

no room sens.recalc. DTheat./room (°C) - Setting a temperature drop for heating water and room temperature. E.g. the value 3 means that if the heating water temperature changes by 3°C, the room temperature will change by circa 1°C. This parameter applies when no room sensor is present.

External blocking input (sensor list) - Setting the clamp to which can be connected an input used for blocking the heating zone externally. It is possible to select the universal sensor inputs (sensors 1 to 5) or a universal binary input on clamp C9 (marked „s“).

turn pump OFF (--) - If this function is on, the zone circulation pump will switch off when the temperature in zone reaches the desired value (with ± 0.3 °C difference).

Input for bivalent valve (sensor list) - Setting the clamp to which will be connected the input signal from bivalent valve (only possible with Lyra/Vega control type). It is possible to select the universal sensor inputs (sensors 1 to 5) or a universal binary input on clamp C9 (marked „s“).

Following parameters are used for better calculation of OTC curve. For more information on settings these parameters visit any domestic-heating-related webpage.

exponent (-) - Projected exponent of heating system. It is recommended to set this parameter to 1,0 - 1,1 for floor heating system and to 1,3 for convectional heating system.

temperature drop (°C) - Projected temperature drop of heating system. First parameter is projected heating water temperature, second parameter heating return temperature.

indoor calculation temperature (°C) - Indoor calculation temperature varies based on the type of building and its rooms. However for majority of applications it is recommended to leave this temperature to 20 °C.

outdoor calculation temperature (°C) - Outdoor calculation temperature depends on the location of the building and it should range from -18 °C to -9 °C.

S 5.2 – setting service parameters for ventilation unit:

zone (on/off) Service switch on / off the zone.

signal min (V) Minimum signal level corresponds to HVAC power 0%.

signal max (V) Maximum signal level corresponds to HVAC power 100%.

percentOFF (V) Power (0 to 100%) which will be set when the HVAC unit is switched off by user.

Summer bypass - Switching on the Summer bypass function. This function is controlled either by zone 1 or zone 2 room sensor (select the sensor in parameter **assign funtion to**). The room sensor is compulsory for switching the zone on – if neither of the zones have room sensor or room controller present then the function could not be switched on. This function opens the bypass flap when the outside temperature is lower than set temperature (user level parameter) on the selected room sensor. The outside temperature has to be higher than set minimum value (**min.out.t.**). It is possible to control this function only in summer mode of selected zone (**Run bypass only in summer mode**).

Input for boost fnc. button 1, 2, 3 (sensor list) - Setting the clamp to which can be connected a button used to switching on the Boost functions 1,2,3 (see user level manual). It is possible to select the universal sensor inputs (sensors 1 to 5) or a universal binary input on clamp C9 (marked „s“).

S 5.3 – floor drying program:
This function has its own manual.

S 5.4 – setting service parameters for solar thermal system:

A solar thermal system may work with one or two consumers. This is done by so called *Oscillating storage tank loading*, when the Controller tries to heat up Consumer No. 1 first. If this is not possible due to too small temperature difference between the collector and consumer, and at the same time the difference for Consumer 2 is sufficient, it will load Consumer 2 for the preset time. After the preset loading time the Controller stops loading Consumer No. 2 and tests if the collector temperature rises. If not, it continues loading Consumer No. 2. If the collector temperature rises, the Controller waits until the difference for loading Consumer No. 1 is met.

solar (active/off) - Switching on solar zone.

sol. cons. 1,2 (active/off) - Switching on separate solar consumers.

Solar consumer 1, or 2:
sensor (sensor list) - Choice of temperature sensor in a solar consumer.

diff. on (°C) - Difference to switch on solar circuit. Difference between solar collector and temperature sensor set in parameter *sensor*.

diff. off. (°C) - Difference to switch off solar circuit.

desired t. (°C) - The desired temperature. Under the normal solar circuit mode, the consumer is heated up to this temperature. As soon as all switched-on consumers are heated up to the demand temperature, the Controller continues heating up to max. temperature.

max. temp. (°C) - Max. temperature. Maximum temperature the solar consumer is heated to under normal mode (the function of solar collectors cooling is turned off).

bore regen. (yes/no) - Set if this consumer is used for ground-source heat pump's deep bore regeneration. Selecting "yes" will start a ground loop circulation pump together with the given consumer.

Oscillating loading

t. increase (°C) - Temperature increase during oscillating loading. If a solar consumer of a higher priority cannot be loaded, the Controller waits for the time set in parameter *idle time*. If the temperature rises after this time by the value set in parameter *t. increase*, the Controller keeps idling. This repeats until the consumer switch-on difference is reached. If this condition is not reached, the tank of lower priority is loaded, supposed the condition of switching difference is met – cf. more details in the description of ..

idle time (min) - Time period the Controller idles, waiting if the solar collector temperature rises. The description see parameter *t. increase*.

sol.cons. 2 (3) (min) - If a consumer of higher priority cannot be loaded, a tank of lower priority is loaded for the time period set in this parameter.

Collector cooling

When this function is on, solar collector is cooled. As soon as the max. temperature is reached (in all active consumers), consumer loading is stopped. When the solar collector temperature exceeds the preset max. collector temperature, the circulation pump starts and the collector is cooled by heating that tank which number is selected in parameter **Solar cons. number for coll./cons. cooling**. If the temperature in this tank exceeds the preset critical temperature, collector cooling is stopped.

Collector cooling on (active/off)

- Switching on the function of collector cooling.

crit.storT (°C) - Collector cooling by heating consumer selected in parameter **Solar cons. number for coll. /cons. cooling** may run only until the consumer temperature set by this parameter is reached. When this temperature is exceeded in this consumer, the collector stops cooling by heating this consumer.

max.coll.T (°C) - Max. collector temperature. When this value is exceeded, collector cooling by heating tank selected in parameter **Solar cons. number for collector /cons. cooling** is started, supposed this function is on..

Solar consumer cooling

If the temperature in consumer selected in parameter **Solar cons. number for coll. /cons. cooling** is higher than that set in parameter *Max. temp. cons.* (e.g. due to collector cooling), this consumer will get cooled via the collector. Cooling shall start if the collector is cooler by at least 6°C than this consumer.

On (active/off) - - Switching on the function of consumer cooling.

Critical collect. temperature

If the temperature set in param. Crit. T is exceeded on a solar collector, solar pump is blocked. This function protects other solar component from destruction by too hot solar fluid.

crit. t (°C) - - Solar collector critical temperature .

Solar cons. number for collector/cons.cooling. (-) - No. of solar consumer used for safety functions of collector and consumer cooling

Solar PWM pump:

Enabling this function allows the IR to control solar PWM pump (low-energy pumps with high efficiency). This control is possible only with a converter from 0-10V to PWM signal connected to the universal analogue output and the output must be enabled for controlling the pump.

The pump is controlled with simple algorithm maintaining the setpoint temperature difference between solar collector temp. and temp. of the active solar consumer. Upon switching the solar pump on the power is set to maximum for the period defined in parameter purge time. Then the power drops to minimum and is controlled with predefined period and control step (maximum rise or drop of pump's power).

solar PWM pump. (off/on) *Switching on the function Solar PWM pump.*

set. differ. (K) *Setpoint temp. difference between collector and active sol. consumer.*

purge time (mm:ss) *Purging time (pump is running at maximum power after switching on).*

PWM profile (sol., heat.) *Selected PWM profile according to VDMA standard (defaults to solar).*

min. power (%) *Minimum PWM pump power.*

max. power (%) *Maximum PWM pump power.*

ctrl. period (s) *Control period, delay of the next control point (sets how often the algorithm interferes with the power of the pump).*

ctrl. step (%) *Step of each control point (how much will be the power of the pump influenced in in one control point defined by control period).*

S 5.5 – setting service parameters for heat pumps – HP:

The Controller can manage either one CTC 400 heat pump or a cascade of up to 10 CTC 400 heat pumps.

After switching on or off one or more heat pumps and returning to user mode it is advisable to reset the Controller by disconnecting it from power supply. It is necessary to wait a couple seconds between de-energizing and energizing the Controller again. After it turns on, the type and number of heat pumps are detected within seconds.

When a demand to start a HP appears, first a circulation pump starts, then with a delay also a fan/brine pump of the respective heat pump, and finally the HP's compressor. After the heat pump switches off, it may not be switched on again before so called restart time expires that is set to 10 minutes as default.

Heat pump No. 1 (address 1) is able to heat a hot water storage tank (DHW). The diverting valve that distributes HP flow between a hot water storage tank and a thermal store diverts in advance before the HP's compressor starts.

HP (active/no) - This activates the function of CTC 400 heat pump control. It shall be active even when just one heat pump is used.

diff. on (°C) - Temperature difference to switch on a heat pump / cascade. A difference between the desired Thermal Store sensor temperature and the real temperature to switch on the heat pump.

diff. off (°C) - Temperature difference to switch off a heat pump / cascade. A difference between the desired Thermal Store sensor temperature and the real temperature to switch off the heat pump.

RC for heat. (yes / no) - Ripple c. for heating. With *no* the heat pump runs disregarded of the Ripple control signal.

Control sensors for HP cascade on/off:

on (sensor list) - control sensor to switch on a HP/cascade

off (sensor list) - control sensor to switch off a HP/cascade. For a cascade, the default choice "*HP1 return*" is not recommended.

No block by Ripple control under set outdoor temp. (yes/no) - HP is not blocked by Ripple c. below the set outdoor temperature

outdoor temp. (°C) - Outdoor temperature below which HP will not be blocked.

delay of next HP in series (min) - If more heat pumps in a cascade are used, each further heat pump is switched on with this delay.

zone pumps off at DHW (yes/no) - If the heat pump runs in DHW heating mode, zone circulation pumps are blocked.

close zone mixing valves at HW (yes/no) - If the heat pump runs in DHW heating mode, mixing valves for heating zones are closed.

Switch at DHW heat. - If there is a concurrent demand for DHW and space heating, HP No. 1 will oscillate between DHW and space heating following the times:

to DHW (min) - Max. time of HP1 running in DHW heating mode under concurrent space heating demand

to heat.wat. (min) - Max. time of HP1 running in space heating mode under concurrent DHW heating demand

Ripp.for DHW (yes/no) - Ripple c. for DHW. With *no* the heat pump runs disregarded of the Ripple control signal.

No block by Ripple c. under set outdoor temp. (yes / no) - Heat pump is not blocked by Ripple c. during DHW heating under the set outdoor temp.

outdoor temp. (°C)- - Outdoor temperature below which HP will not be blocked by Ripple c. during DHW heating.

Menu Heat pump 1

In this menu, specific parameters for heat pump 1 are set.

State (on/off) - switching on/off the specific heat pump

Max.flow t. (°C) - Setting max. flow temperature from a heat pump. If the flow temperature exceeds this value, the HP will switch off. It will also switch off when the flow temperature exceeds a value set by the manufacturer for a specific HP type (see the respective Service Manual).

Max.return t. (°C) - Setting max. return temperature to a heat pump. If the return temperature exceeds this value, the HP will switch off. It will also switch off when the return temperature exceeds a value set by the manufacturer for a specific HP type (see the respective Service Manual).

Min.outd.t. (°C) - Minimum outdoor temperature for a heat pump operation. If the outdoor temp. drops below this value, the heat pump will switch off. It will also switch off when outdoor temp. drops below a value set by the manufacturer for a specific HP type (see the respective Service Manual).

Max.outd.t (°C) - Max. outdoor temperature. If the outdoor temperature rises above this value, the HP will switch off.

Max.brine t. (°C) - Max. temperature for the brine circuit. If the brine temperature rises above this value, the HP will switch off. Applies to ground source heat pumps only.

Restart time (min) - Min. delay between 2 heat pump starts.

Min.run.time - Min. heat pump running time. It is activated after compressor start, or after DHW heating is finished (if the demand for heating is above 10°C), or after defrosting.

External blocking input (sensor list) - Setting the clamp to which can be connected an input used for blocking the heat pump externally. It is possible to select the universal sensor inputs (sensors 1 to 5) or a universal binary input on clamp C9 (marked „s“).

S 5.6 – HP operating data

In this menu, detailed info on heat pump 1 are shown.

Menu of Heat pump 1 current data

Flow temp. (°C)	- HP flow temp.
Return t. (°C)	- HP return temp.
Hot gas (°C)	- HP compressor hot gas temp.
Cond.temp. (°C)	- HP condensing temp.
Cond.press. (bar)	- HP condensation pressure
Evapor.1 t. (°C)	- Temperature of discharged air/incoming brine circuit
Evapor.2 t. (°C)	- Temperature of brine into the ground loop from HP
Outdoor t. (°C)	- Outdoor temp. to T _C (air source HPs only)
Evapor. t (°C)	- HP evaporation temp.
Suction t. (°C)	- HP compressor intake temp.
Superheat (°C)	- Superheat at HP compressor suction
Evap.press. (bar)	- HP Evaporation pressure
EEV opened (%)	- HP EEV opened in %
HP SW ver. (-)	- HP SW ver.
EEV SW ver. (-)	- HP EEV electronics ver.

S 5.7 – HP blocking

	1	2	3	4
1)	28 . 7	15 : 51	- HP 1	
HP comm .				
2)	0 . 0	00 : 00	- HP 0	5

- 1 – error serial number (1 – 10)
- 2 – date & time of error occurrence
- 3 – information if the error is still active
- 4 – number of HP with error (1 – 10)
- 5 – error type

S 5.8 – setting service parameters for a switched auxiliary source:

source (active/off) - Switching on an auxiliary source on service level.

diff. on (°C) - Setting a temperature difference between the desired Thermal Store upper and real temperature for switching on an auxiliary source.

diff. off (°C) - Setting a temperature difference between the desired Thermal Store upper and real temperature for switching off an auxiliary source.

delay (min) - Setting the delay for auxiliary source start after the demand for start appeared.

block out.t (°C) - Setting outdoor temp. above which an auxiliary source is blocked.

Ripple cont. (yes/no) - Ripple control. With no the heat pump runs disregarded of the Ripple control signal.

Auxiliary source at HP failure (on/off) - If *On*, a boiler is switched on in case of a heat pump fault. For cascades, all the heat pumps must be out of operation.

Auxiliary source contr. sens. - Control sensors to switch on/off an auxiliary source

S 5.9 – setting service parameters for an auxiliary source with OT:

source (active/off) - Switching on an auxiliary source on service level.

DHWE heating (yes/no) - If *yes*, OT boiler is started simultaneously with DHW-E zone demand. DHW-E continues to be active and can be used switch the DWH heating in boilers that require this

DHW in boiler (0 / 1 / 2) - Determines a DHW type in the boiler:
0 - Boiler with no integrated DHW tank
1 - Boiler with a hot water storage tank and thermostat
2 - Boiler with a hot water storage tank and temperature sensor

- delay (min)** - Setting the delay for auxiliary source start after the demand for start appeared.
- block. out.t. (°C)** - Setting outdoor temp. above which an auxiliary source is blocked
- Ripple cont. (yes/no)** - Ripple control. With *No* the auxiliary source runs disregarded of the Ripple control signal.
- max. temper. (°C)** - Max. source temperature. When this temperature is exceeded, the source is switched off. At the same time, this is the upper limit for demands (e.g. if a DHW demand is 95°C and a boiler max. temp. is 80°C, the DHW temperature demand sent to the boiler is 80°C).
- at HP fail. (yes/no)** - Switching on the source when the heat pump shows a fault. In case of an active heat pump fault (or of all heat pumps in a cascade) the OT source acts as a main heat source instead of the heat pump (takes over heating/DHW demands from the heat pump).
- commun.speed (0 - 9)** - Speed of OT communication with the source. The parameter sets the communication bus speed between the IR and source. Lower numbers mean higher speed but higher inclination to a communication fault. The recommended setting is 4 or 5..

S 5.10 – setting service parameters of a modulated (0-10V) heat source

- source 0-10V (yes/no)** Switching on a 0-10V signal controlled heat source on service level.
- output (power/temp.)** Setting the type of output signal. With **power** selected, the 0-10V signal is in direct relationship to the desired source output (in the range adjustable on the respective adjustment page). With **temp.** selected, the 0-10V output signal is in direct relationship to the desired temperature.
- Ripple c. (yes/no)** Settings for 0-10V source control by Ripple control signal.
- DHWE heating (yes/no)** If yes, OT boiler is started simultaneously with DHW-E zone demand. DHW-E continues to be active and can be used switch the DWH heating in boilers that require this
- sensor (sensor list)** Control sensor for a 0-10V source.
- max. temp. (°C)** Setting of max. flow temperature from a heat source. This temperature will be used as the upper limit value for a desired boiler temperature.

S 5.11 – setting service parameters for DHW heating by a heat pump (DHW):

- on (active/off)** - Switching on DHW heating by a heat pump on service level
- diff. on (°C)** - Setting the DHW heating switch-on difference
- diff. off (°C)** - Setting the DHW heating switch-off difference
- Control sensors** - Control sensor to switch on/off the DHW heating

S 5.12 – setting service parameters for DHW heating by an additional source (DHW-E):

on (active/off) - Switching on DHW heating by an el. heating element on service level

diff. on (°C) - Setting the switch-on difference

diff. off (°C) - Setting the switch-off difference

Ripple c. (yes/no) - Ripple control. With No the el. heating element operates disregarded of the Ripple control signal.

Input for circ. button (sensor list) - Setting the clamp to which can be connected a button used to switching on the Immediate circulation. It is possible to select the universal sensor inputs (sensors 1 to 5) or a universal binary input on clamp C9 (marked „s“).

External blocking input (sensor list) - Setting the clamp to which can be connected an input used for blocking the DHW-E heating externally. It is possible to select the universal sensor inputs (sensors 1 to 5) or a universal binary input on clamp C9 (marked „S“).

S 5.13 – setting service parameters for thermal store heating:

on (active/off) - Switching on Thermal Store zone on service level

S 5.14 – sensor management:

The temperature measured by the Controller may differ from a real temperature due to defects. The measured value may be affected e.g. by the preciseness of the temperature sensor, the length and cross section of the cable used for sensors, by the quality of contact between the temperature sensor and the medium measured. The temperature data can be adjusted by offset in the range from -15.0 to +15.0 °C. Sensors of zones 3 to 6 can not be adjusted here, they can only be adjusted from the web control panel.

connected (yes/no) - No option shall be selected in case no temperature sensor is connected (to avoid the program reporting an error when the sensor is disconnected). For some temperature sensors, this option cannot be changed. The setting depends on the system configuration (e.g. when DHW zone is switched on in service menu, the HP sensor is activated, while when the DHW zone is switched off, the sensor deactivates automatically).

adjustment (°C) - Temperature sensor offset

state (OK / error) - The sensor state – if the sensor is in an error state (either a too high or a too low temperature is sensed), the text *fault* is displayed.

S 5.15 – other service parameters:

password - Setting a numeric password for access to the menu service level.

Frost protection:

When Frost protection is on, the temperature is monitored for a switched off zone. Should the outdoor temperature drop below the value set in the parameter *out. temp.*, then the heating water temperature to the zone is kept at value set by parameter *water temp.*

state (active / off) - Turning frost protection On/Off.

out. temp. (°C) - Setting outdoor temperature limit below which Frost prot. is activated.

water temp. (°C) - Heating water temperature kept in a zone when Frost prot. is active.

Critical ThSt temp.:

If the temperature in Thermal Store exceeds the set critical temperature, cooling will start with heating into all zones switched on in service menu, i.e. incl. those switched off in user menu. During cooling, the zone pump is on and the max. temperature is set for the zone (*Max.t to zone*). Cooling will be finished when the Thermal Store temperature drops by 5°C.

Temper. (°C) - Setting critical temperature in Thermal Store.

Website password reset (no/reset) - Selecting reset will reset the website service level password and username to default values.

S 5.16 – Fire module:

This add-on module is designed to control a fireplace connected into a heating system. At the same time it permits efficient control of heating a hot water storage tank from a thermal store via a 3-way zone valve.

module (off/active) - Option if the module is used in the system.

ThSt sensor for Fire (sensor list) - Selecting a sensor for differential function of switching on a fire circulation pump.

min. Fire temp. (°C) - Setting the water temperature from fireplace above which the fireplace circulation pump starts.

dif. Fir/ThS on (°C) - Setting the switch-on difference to start the fire pump.

dif. Fir/ThS off (°C) - Setting the switch-off difference to stop the fire pump.

max. ThSt temp (°C) - Max. temperature in thermal store (or exactly at the sensor selected in parameter *ThSt sensor for Fire* for fire circulation pump operation.

DHW heating by ThSt:

DHW pump (no/yes) - Turning on/off the function of heat transfer from thermal store to hot water storage tank.

dif. on (°C) - Setting the switch-on difference for differential function to start DHW pump.

dif. off (°C) - Setting the switch-off difference for differential function to stop DHW pump.

DHW sens. for DHW pump (sensor list) - Selecting a sensor in hot water storage tank for differential function to start DHW pump.

ThS sens. for DHW pump (sensor list) - Selecting a sensor in thermal store for differential function to start DHW pump.

S 5.17 – UNI module:

This is a universal add-on module for IR10 and IR12 controllers.
The module features the following functions:

- Switching on the add-on module
- Selecting sensor 1
- Selecting sensor 2
- Thermostat 1
- Thermostat 2
- Differential thermostat
- Delay
- Overrun
- Timer

The function logic is designed in such a way that the output is closed when the add-on module is switched on and all the permitted functions are fulfilled, see fig. below. A function not permitted is equivalent to a closed switch.

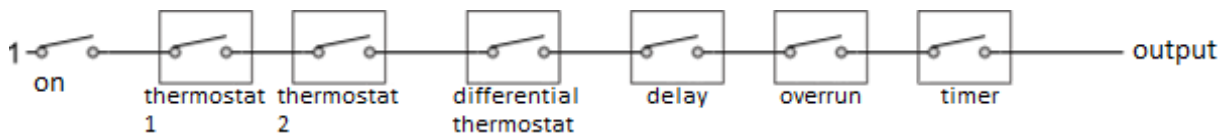

It is obvious from the picture that the Delay function can delay signal from thermostat and diff. thermostat functions, the Overrun function can hold disconnection (switching off) from thermostat, diff. thermostat and delay functions. The Timer function is superior over the preceding functions.

Description of separate functions and parameters of the add-on module

module - Switching on the add-on module.

Sens. 1 - Selection of sensor 1 for UNI module functions

Sens. 2 - Selection of sensor 2 for UNI module functions

Thermostat 1 (2) demand (°C) - Thermostat function related to temperature input 1 (2)
- Thermostat 1 (2) demand (set) temperature

d. on/off (°C) - Thermostat 1 (2) switch-on and switch-off temperature difference.

Thermostat 1 (2) is used

for cooling (no/yes) - If the **yes** option (cooling mode) is selected then the Thermostat 1 (2) function will be switched on when the temperature reaches demand plus switch-on difference and will be switched off again if the temperature drops below demand minus switch-off difference. If the **no** option (heating mode) is selected then the Thermostat 1 (2) function will be switched on when the temperature drops below demand minus switch-on difference and will be switched off again if the temperature reaches demand plus switch-off difference.

Call for heat

from Thermostat 1 (2) (on/off) - Switch-off temperature for Thermostat 1 (2) will be taken over as the desired temperature for heat sources. Valid only if Thermostat 1 (2) is set in "heating" mode. When Timer function is also On, the request will be taken over during active time period only.

- Differential thermostat:
diff. on (°C) - differential thermostat function
- Switch-on difference between temperatures t1 and t2.
- diff. off (°C)** - Switch-off difference between temperatures t1 and t2.
- Delay:
period (minutes) - output delay function
- Delay time in case when all the preceding functions are fulfilled.
- Overrun:
overrun (minutes) - overrun function / output delayed switch-off
- Overrun time after the preceding functions are switched off.
- Timer:
on 1 (hh:mm) - timer functions with two time periods
- The first period switch-on time
- off 1 (hh:mm)** - The first period switch-on time
- on 2 (hh:mm)** - The second period switch-on time
- off 2 (hh:mm)** - The second period switch-off time.

reset state of T1&T2 with every start of the period of the program - When this function is On, at every start of time period in time program the state of both thermostats, T1 and T2, will be reset according to the current temperatures

S 5.18 – HW addresses of add-on modules:

An add-on module can be connected to the Controller on CIB bus. The module is also power-supplied from this bus. After the module is connected, its HW address shall be set in the Controller, otherwise the module will not work together with the Controller. The module's HW address is printed on its side.

Module addr. (-) - Hexadecimal HW address of a module

load address (no/yes) - After entering the HW address, confirm *YES* to load the address into the Controller. The lower line will read *OK* and the green RUN lamp on the module will start flashing.

S 5.19 – IP addresses:

Setting the IP address, network mask, gateway, DNS server address, possibly also DHCP.

IP (192.168.100.014) - Controller IP address.

Mask (255.255.252.000) - Network mask the Controller is connected to

GW (000.000.000.000) - IP address of the default gateway the controller is connected to.

DNS (008.008.008.008) - IP address of DNS server.

Set new IP (yes/no) - Confirmation of the new IP addresses set. The Controller will not work with the new IP addresses without this confirmation.

Set DHCP (yes/no) - When Yes is selected, the Controller will receive the address from the DHCP server. If the IP address cannot be received within 4 seconds (e.g. DHCP server is not present in the LAN), the IP address set above will be used as a replacement configuration.

MAC (00.00.00.00.00.00) - MAC address of the Controller.

S 5.20 – RegulusRoute:

RegulusRoute service enables remote access to the Controller avoiding the need to use a public IP address. If you wish to have this service configured, kindly contact Regulus.

RegulusRoute (yes/no) - Enabling RegulusRoute service

Status - RegulusRoute service state

IR12 name - Controller login name to RegulusRoute service

IR12 password - Controller login password to RegulusRoute service

Set new Regulus Route parameters (yes/no) - When Yes is selected, the Controller will start using the newly entered name and password for RegulusRoute service (parameters can be entered via web interface only)

S 5.21 – output test:

When *Output test* in Service Menu is entered, all outputs from the Controller are switched off. Then separate outputs can be tested. The output turns on when a display with the name of the output in question is shown and the option *test* = 1 selected. On leaving a display with the option *test* = 1, the respective output switches off..

Outputs used in zones 3 to 6 can not be tested from the display, they can only be tested from we control panel.

termin - Terminal number for the respective Controller output.

Operat - Description of the output function.

test (0,1) - State of the tested output, 1 = output on

S6 – Web Server – service level:

IR12 Controller is equipped with integrated web server that enables displaying either User or Service screen.

S 6.1 Access to Service web interface, checking the IP address of the Controller:

In order to access the Controller’s interface via web browser, you need to know its IP address.

The IP address set in the Controller can be revealed by hitting *DISP* key. Then pressing arrow down key will display the IP address of the device, its mask and gateway.

Entering the IP address into the address bar of your browser will open a log-in window that enables visiting either User or Service level.

For example, if the controller address is in the form 010.000.000.014, it is entered in the browser command line in the form 10.0.0.14.

level	username	password
user	user	user

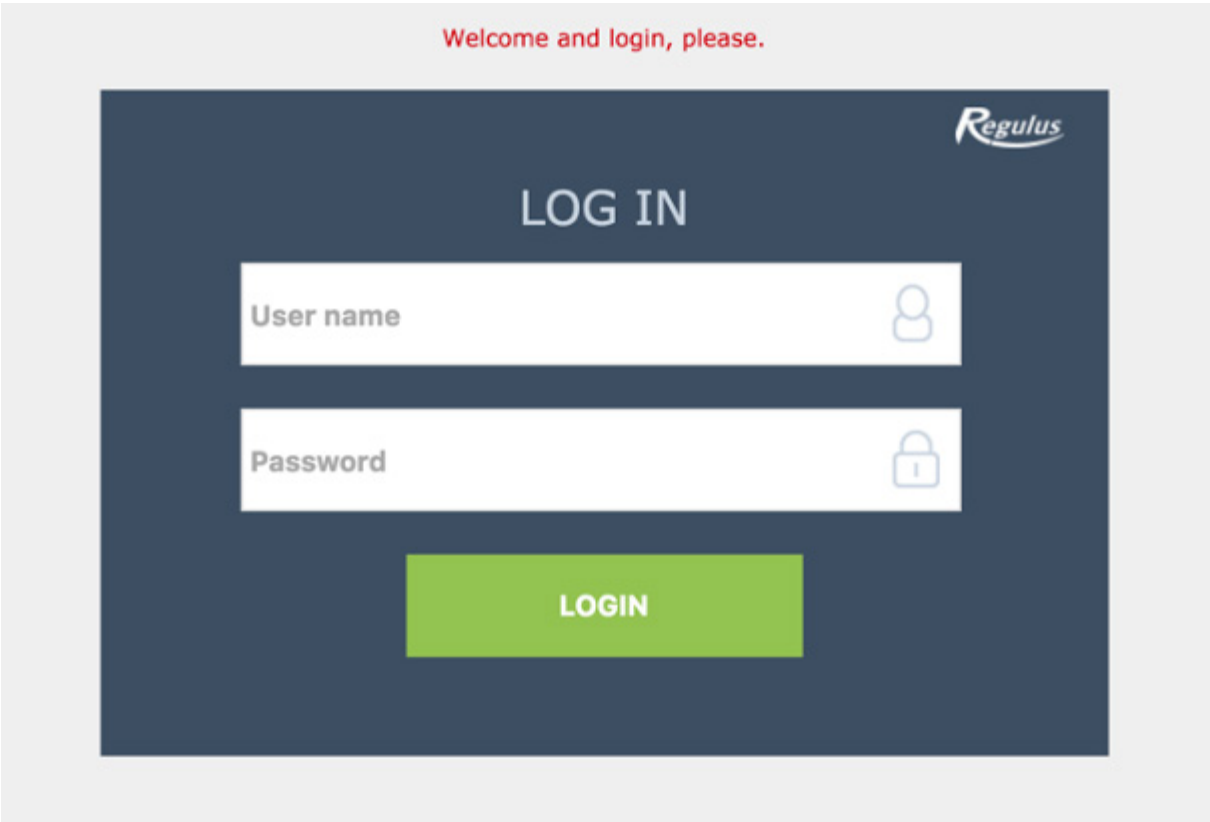

Login window

After successful login with the Service username and password the welcome screen appears with the Service Menu.

S7 - RC21 IR Room Unit, wiring

RC21 IR Room unit can be connected to the Controller. It involves a temperature sensor, keys for temperature correction and for a permanent temperature level, either *Comfort* or *Setback*.

The room unit shall be wired to the Controller with a shielded twisted cable 4x0.5 or 3x0.5, or 4x0.75 or 3x0.75 (e.g. JYTY).

Terminal board description:

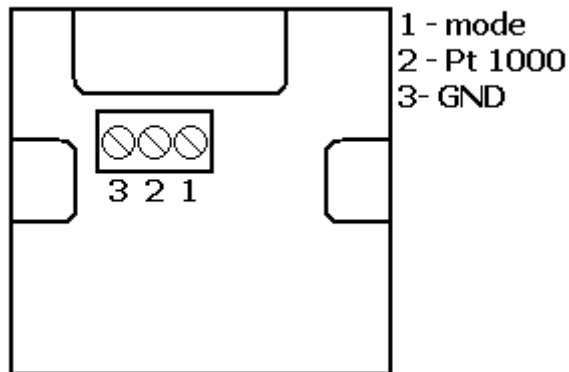

Room unit connection to the Controller:

Room unit in Zone 1:

Unit terminal 1 → IR12 terminal B4 (t3) (sensor 4)

Unit terminal 2 → IR 12 terminal C7 (t12) (Zone 1)

Unit terminal 3 → IR 12 terminals B1,C1 (T_{GND})

Room unit in Zone 2:

Unit terminal 1 → IR12 terminal B5 (t4) (sensor 3)

Unit terminal 2 → IR 12 terminal C6 (t11) (Zone 2)

Unit terminal 3 → IR 12 terminals B1,C1 (T_{GND})

The RC21 sensor type needs to be enabled on the Service level.

S8 - Room thermostat, wiring

Thermostat with volt-free contact can be connected to the IR12 controller (one to each heating zone).

Thermostat in Zone 1 should be wired to terminal B4 (t3) (sensor 4) and one of the terminals B1,C1 (T_{GND}).

Thermostat in Zone 2 should be wired to terminal B5 (t4) (sensor 3) and one of the terminals B1,C1 (T_{GND}).

The Thermostat sensor type needs to be enabled on the Service level.

WARRANTY CERTIFICATE

IR 12 Heating Controller

Seller: Date of Purchase:

WARRANTY CONDITIONS

1. The warranty period is 24 months from the date of purchase.
2. The product shall be installed and commissioned by a competent company or a person trained by the manufacturer.
3. When claiming warranty, this Warranty Certificate must be submitted together with the purchase receipt.
4. The warranty is valid only when the technical conditions set by the Manufacturer, installation manual and instructions in the documentation and on the product itself are maintained.
5. The warranty does not cover defects caused by external conditions or improper operation conditions, defects caused by usual wear and tear, further when the product is not used in compliance with its purpose and when the defect was caused by mechanical damage, improper handling, tampering by a third person, improper installation, improper stocking, natural disaster etc.

COMMISSIONING

Company:

Date:

Rubber stamp print and signature of the installing person: